

Product Datasheet

TOP1070

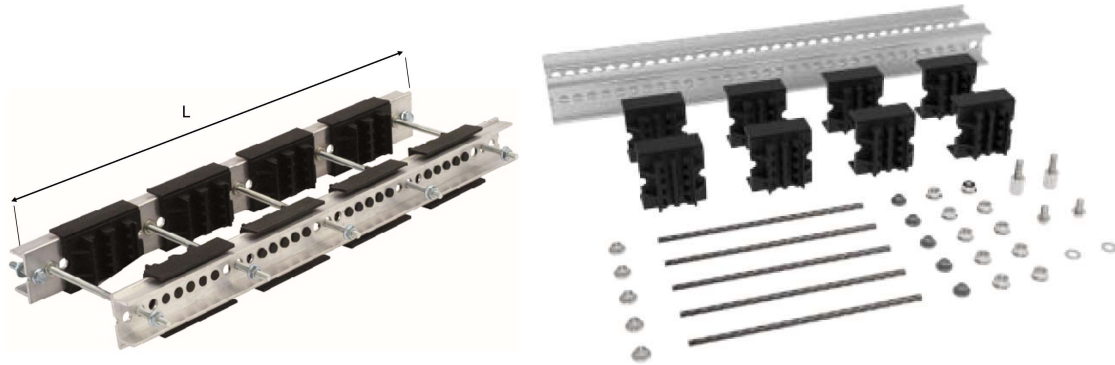

Main

Family	Bar supports
Version	Pre-assembled bar supports
Code	TOP1070
Reference	TOP 2/5TN-600
Number per package	1
Type	T+N
L (mm)	600

This set is made of insulating blocks for 5 mm thick bars and is made of all the screws and tie-rods needed to make T+N (3-pole + neutral) configured bar support.

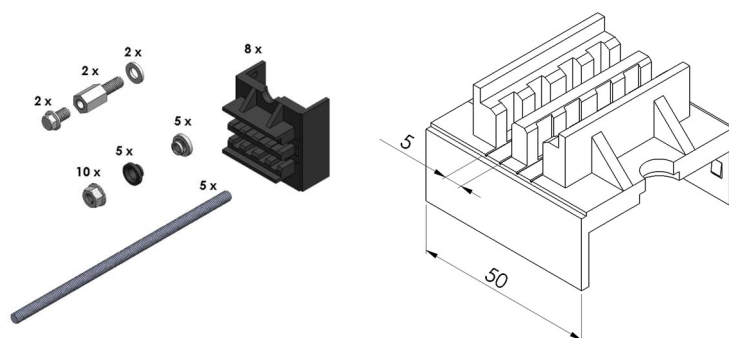

TOP1010

Technical Features

Rated Voltage: 1000 V AC / 1500 V DC

Max working temperature: 125 °C

Support profile: see TOP1000

Insulating blocks

Made in PA6,6 reinforced 35% Fiberglass

Self-extinguishing UL94-V0

Color: black

Certifications

UL Recognized component with file n° E300607

Please contact Teknomega for non-specified tolerances.