

Product Datasheet

TOP1040

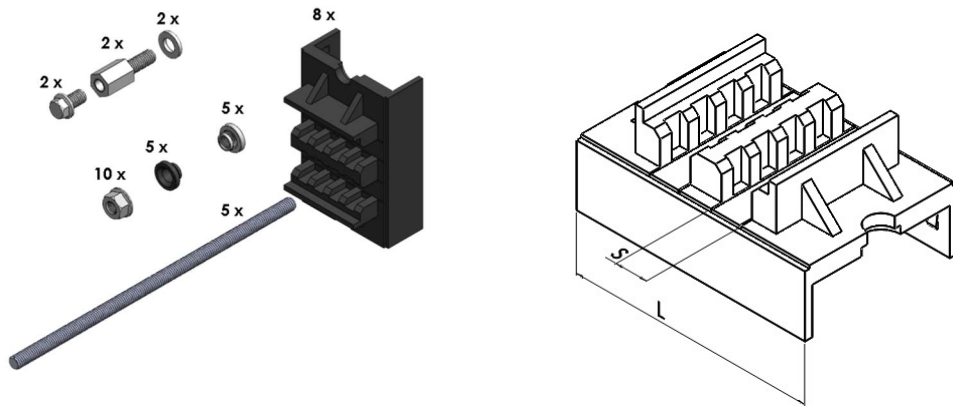

This set is made of insulating blocks for 10 mm thick bars and is made of all the screws and tie-rods needed to make T+N (3-pole + neutral) configured bar support.

Main

Family	Bar supports
Version	Blocks and screw set
Code	TOP1040
Reference	TOP 2/10TN
Number per package	1
Type	T+N
Total No. of blocks	8
No. of tie-rods	5
No. of bars	1 ÷ 2
s (mm)	10
bar min-max H (mm)	30-130
L (mm)	75

Technical Features

- Rated Voltage: 1000 V AC / 1500 V DC
- Adjustable distance between phases
- Exceptional resistance to short-circuits
- Bar thickness 10 mm
- Max working temperature: 125 °C

Insulating blocks

- Made in PA6,6 reinforced 35% fiberglass
- Self-extinguishing UL 94-V0
- Color: black

Certifications

- Compliant with standard IEC 61439-2
- Q TOP was tested in ACAE laboratory IA01 on electrical and mechanical resistance properties
- CERTIFICATES ACAE-LOVAG No.:
 - 15.001 - A 15.002 - A015.003
- UL recognized component with file n° E300607

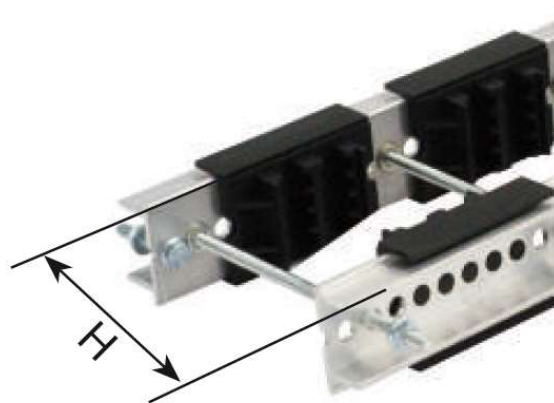

Please contact Teknomega for non-specified tolerances.