

Product Datasheet

RPQ1005

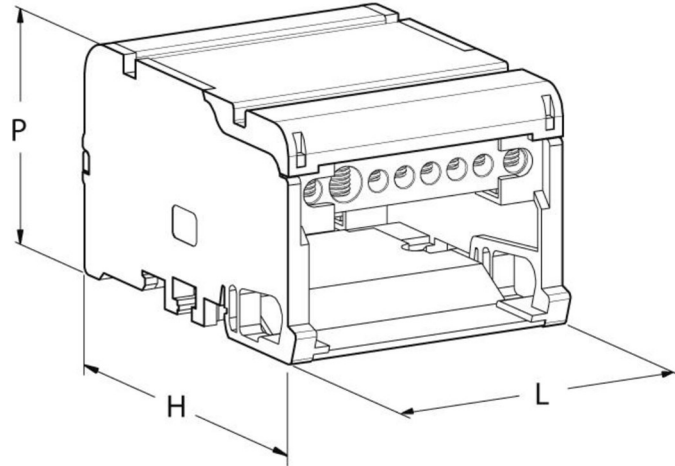

Main

Family	Distribution Blocks
Version	4 Poles 125 A
Code	RPQ1005
Reference	RPQ 125-10
Number per package	1
L (mm)	100
H (mm)	84
P (mm)	50
Fix. hole space (mm)	80
Weight (g)	300
Continuous working temperature (°C)	Max +105 °C

Technical Features

Insulating body: PA 6, UL 94-V0, halogen free, gray RAL 7035

Cover: PC, UL 94-V2, transparent yellow

Conduction block: Brass

Screws: Galvanized steel

Halogen free

Index protection IP10

Insulation between phases

Front removable protection screen

Quick hook-up on DIN rails

Compliant with standard IEC 60947-7-1

Technical Data

Type	4 Poles, 10 Outputs					
In: 125 A	No.	Dim. (mm)	Stripped wire (mm ²)	Wire with ferrule (mm ²)	Torque (Nm)	Screw
IN →	1	∅ 9	10 to 35	10 to 25	2	M5
← OUT	1	∅ 9	10 to 35	10 to 25	2	M5
← OUT	2	∅ 7.5	10 to 25	6 to 16	2	M5
← OUT	7	∅ 5.5	2.5 to 10	1.5 to 10	2	M5
I _{cw} (kA)	4.2					
I _{pk} (kA)	18					
U _i (V)	1000					

I_{cc pk} = Short-circuit current peak value expressed in kA

I_{cw} = Effective value of short-circuit current, duration equal to 1 second, expressed in kA as per standard IEC 60947-7-1

U_i = Nominal Insulation voltage

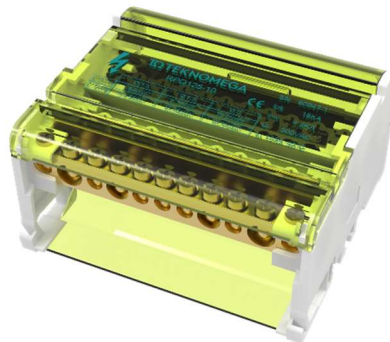

Please contact Teknomega for non-specified tolerances.