

Product Datasheet

MCR1025

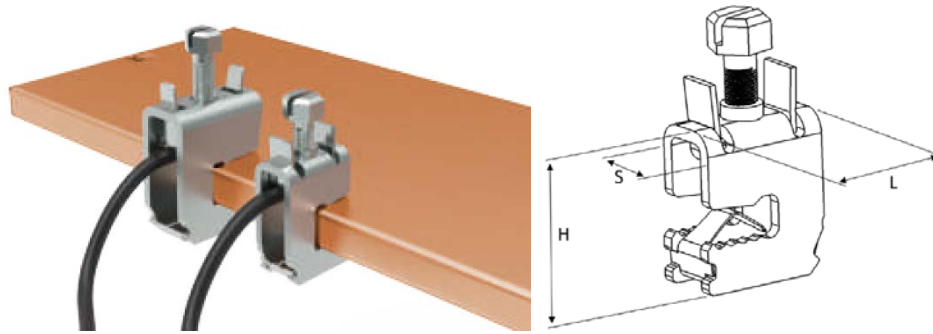

Terminals for 10 mm thick bars

Main

Family	Accessories for busbars
Version	Terminals for cable
Code	MCR1025
Reference	MCR 10x35
Number per package	10
H: Height (mm)	37
L: Length (mm)	29
S: Width (mm)	16
Cross section (mm ²)	16 ÷ 35
Torque (Nm)	6

Technical Features

Passivated galvanized steel

Connections on solid bars 10 mm thick

Suitable for cable cross-sections: from 16 to 35 mm²

Compliant with: EN 60998-1

Cable clamps can connect 1 cable each

Advantages

Easy and quick to use, without punching, even on already mounted bars.

Positioning spring

Indirect clamping with plate to prevent damage to files

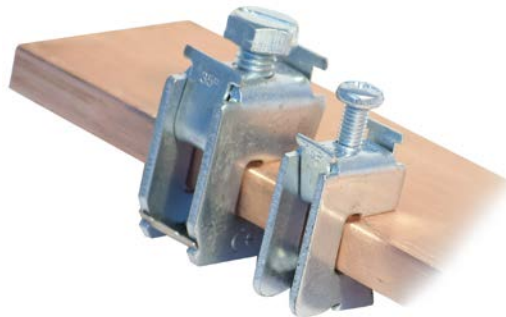

Please contact Teknomega for non-specified tolerances.