

## Product Datasheet

### MCR1017

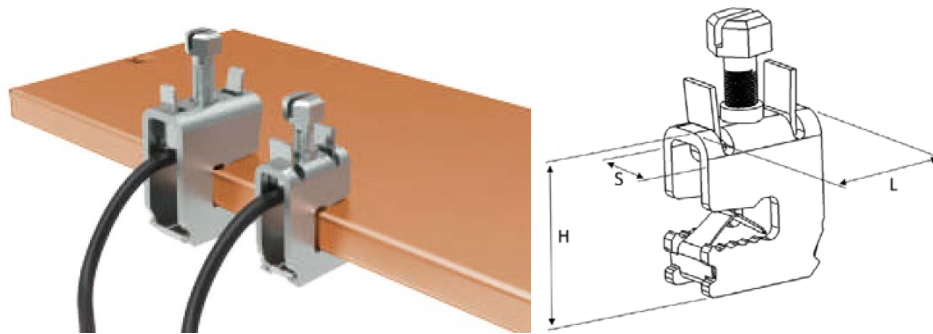

Terminals for 5 mm thick bars

#### Main

Family	Accessories for busbars
Version	Terminals for cable
Code	MCR1017
Reference	MCR 5x185
Number per package	10
H: Height (mm)	50
L: Length (mm)	40
S: Width (mm)	28
Cross section (mm <sup>2</sup> )	120 ÷ 185
Torque (Nm)	30

### Technical Features

Passivated galvanized steel

Connections on solid bars 5 mm thick

Suitable for cable cross-sections: from 120 to 185 mm<sup>2</sup>

Compliant with: EN 60998-1

Cable clamps can connect 1 cable each

### Advantages

Easy and quick to use, without punching, even on already mounted bars.

Positioning spring

Indirect clamping with plate to prevent damage to files

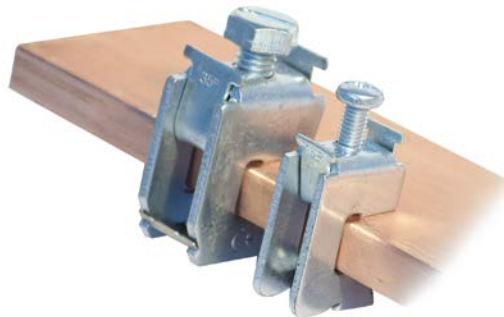

Please contact Teknomega for non-specified tolerances.