

## Product Datasheet

### MCR1015

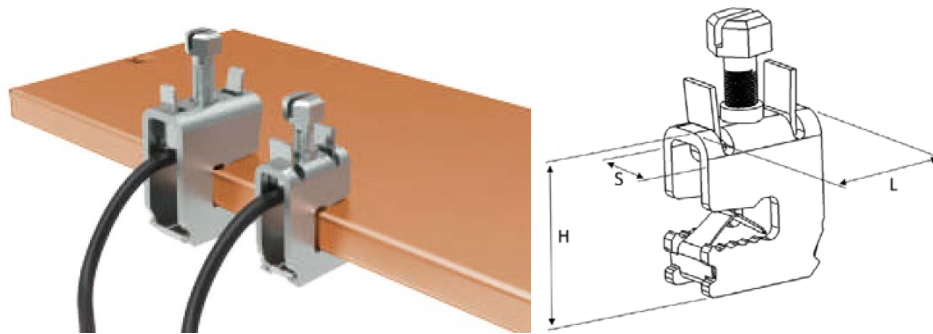

Terminals for 5 mm thick bars

#### Main

Family	Accessories for busbars
Version	Terminals for cable
Code	MCR1015
Reference	MCR 5x120
Number per package	10
H: Height (mm)	44
L: Length (mm)	34
S: Width (mm)	24
Cross section (mm <sup>2</sup> )	70 ÷ 120
Torque (Nm)	15

### Technical Features

Passivated galvanized steel

Connections on solid bars 5 mm thick

Suitable for cable cross-sections: from 70 to 120 mm<sup>2</sup>

Compliant with: EN 60998-1

Cable clamps can connect 1 cable each

### Advantages

Easy and quick to use, without punching, even on already mounted bars.

Positioning spring

Indirect clamping with plate to prevent damage to files

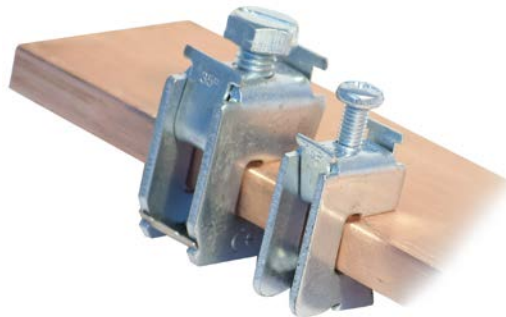

Please contact Teknomega for non-specified tolerances.