

Product Datasheet

MCR1010

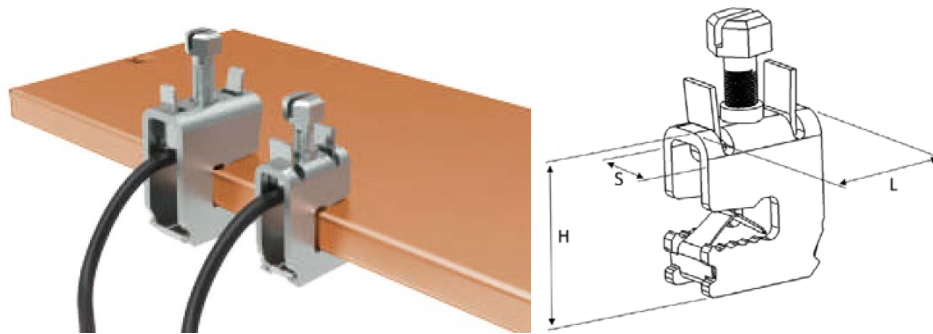

Terminals for 5 mm thick bars

Main

Family	Accessories for busbars
Version	Terminals for cable
Code	MCR1010
Reference	MCR 5x70
Number per package	10
H: Height (mm)	39
L: Length (mm)	31
S: Width (mm)	21
Cross section (mm ²)	35 ÷ 70
Torque (Nm)	10

Technical Features

Passivated galvanized steel

Connections on solid bars 5 mm thick

Suitable for cable cross-sections: from 35 to 70 mm²

Compliant with: EN 60998-1

Cable clamps can connect 1 cable each

Advantages

Easy and quick to use, without punching, even on already mounted bars.

Positioning spring

Indirect clamping with plate to prevent damage to files

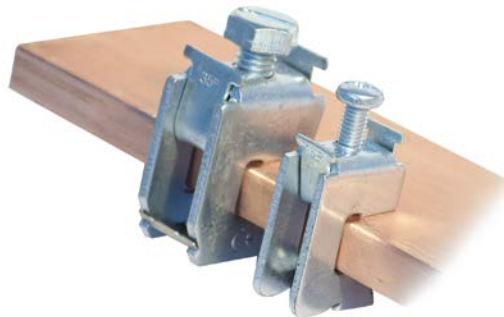

Please contact Teknomega for non-specified tolerances.