

## Product Datasheet

### ITB1030

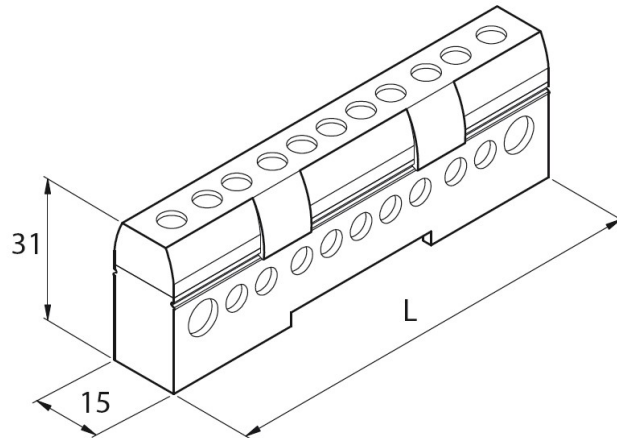

#### Main

Family	Unipolar Terminal Blocks
Version	1 Pole 80 A
Code	ITB1030
Reference	ITB 80-7 G
Color	Green
Number per package	10
Weight (Kg)	0.046
L (mm)	63

Type	Ø holes (mm)	n° holes	Stripped wire (mm <sup>2</sup> )	Wire with ferrule (mm <sup>2</sup> )	Tightening Torque (Nm)
1	7.5	2	4 ÷ 16	2.5 ÷ 16	2
2	5.5	5	2.5 ÷ 6	1.5 ÷ 6	1.5

## Technical Features

**Insulating body:** PA 6, UL 94-V0, Green RAL 6024

**Cover:** PC UL 94-V0, transparent yellow

**Conduction block:** Brass

**Screws:** Galvanized steel

Direct mounting on DIN rail or support ITB2000

Nominal insulation voltage: 1000 V

Compliant with standard **EN 60947-7-1**

Halogen free

Grade IP20B

Maximum working temperature: +105 °C



Please contact Teknomega for non-specified tolerances.