

Product Datasheet

ITB1020

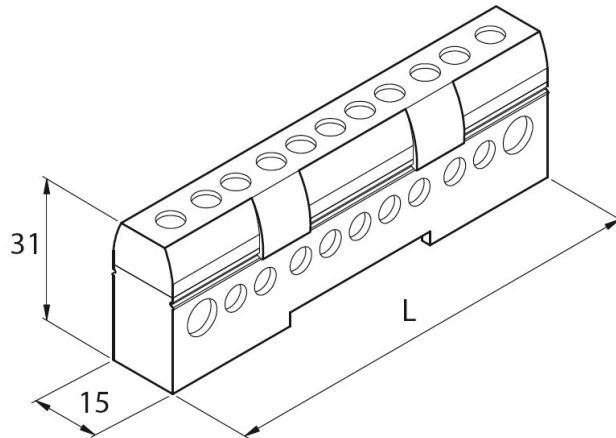

Main

Family	Unipolar Terminal Blocks
Version	1 Pole 80 A
Code	ITB1020
Reference	ITB 80-11 B
Color	Blue
Number per package	10
Weight (Kg)	0.070
L (mm)	95

Type	Ø holes (mm)	n° holes	Stripped wire (mm ²)	Wire with ferrule (mm ²)	Tightening Torque (Nm)
1	7.5	2	4 ÷ 16	2.5 ÷ 16	2
2	5.5	9	2.5 ÷ 6	1.5 ÷ 6	1.5

Technical Features

Insulating body: PA 6, UL 94-V0, Blue RAL 5012

Cover: PC UL 94-V0, transparent yellow

Conduction block: Brass

Screws: Galvanized steel

Direct mounting on DIN rail or support ITB2000

Nominal insulation voltage: 1000 V

Compliant with standard **EN 60947-7-1**

Halogen free

Grade IP20B

Maximum working temperature: +105 °C



Please contact Teknomega for non-specified tolerances.