

Product Datasheet

ISO3010

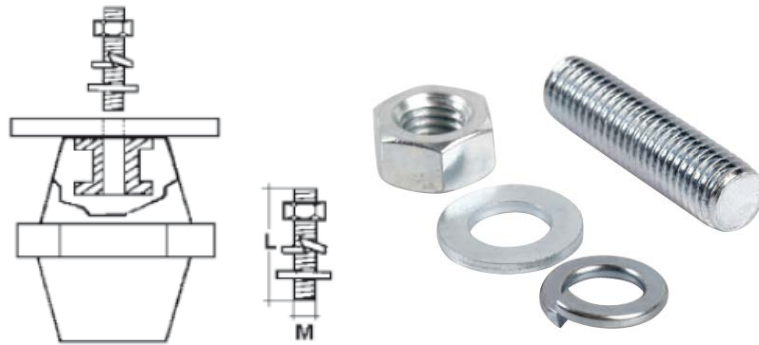

Main

Family	Wiring accessories
Version	Threaded studs for insulators
Code	ISO3010
Reference	ISO PM8x30
Number per package	25
M	M8
L	30

Technical Characteristics

Made of galvanized steel class 8.8

Complete with nut, flat washer and anti-loosening washer

Threaded studs with hexagonal socket, to be tightened with Allen wrenches

Please contact Teknomega for non-specified tolerances.