

## Product Datasheet

### ISO3005

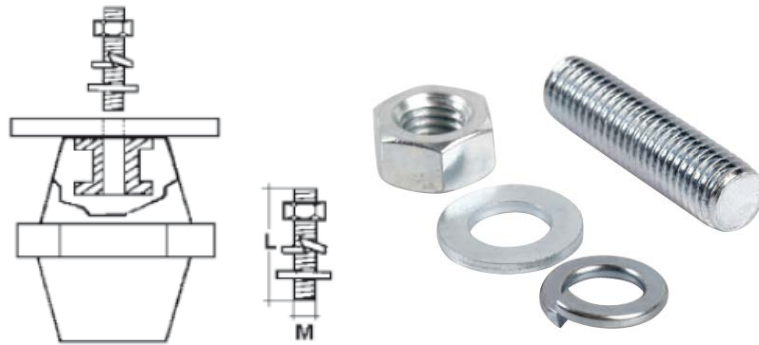

#### Main

Family	Wiring accessories
Version	Threaded studs for insulators
Code	ISO3005
Reference	ISO PM6x30
Number per package	25
M	M6
L	30

#### Technical Characteristics

Made of galvanized steel class 8.8

Complete with nut, flat washer and anti-loosening washer

Threaded studs with hexagonal socket, to be tightened with Allen wrenches

Please contact Teknomega for non-specified tolerances.