

Product Datasheet

ISO2225

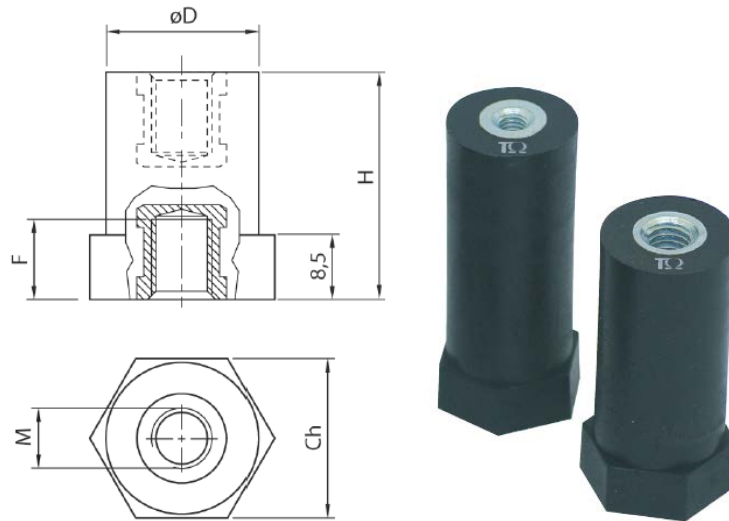

Main

Family	Low voltage insulators	
Version	Spacing columns in polyamide	
Code	ISO2225	
Reference	CLN 50M5-20	
Number per package	25	
Weight (Kg)	0.032	
Dimensions (mm)	H=50 Ch=21 D=20 F=9	
Type	Hexagonal	
Thread Size	M5	
Force Characteristics	Tightening torque*	6 Nm
	Tensile strength	8 kN
	Compressive strength	45 kN
	Flexural strength	2.2 kN

*Maximum tightening torque value suggested for 8.8 class screws

Technical Characteristics

Insulation

Polyamide 6,6 reinforced with 35% fiberglass

Halogen Free

Self-extinguishing: UL 94-V0

Glow Wire Flammability Index: 960 °C

1,5% moisture absorption as per ISO 62

Color: black

Threaded Inserts

Galvanized steel

Finished product

Rated voltage: 1000 V AC/1500 V DC

Working temperature: -40 ÷ 125 °C

UL Recognized with file n° 300607

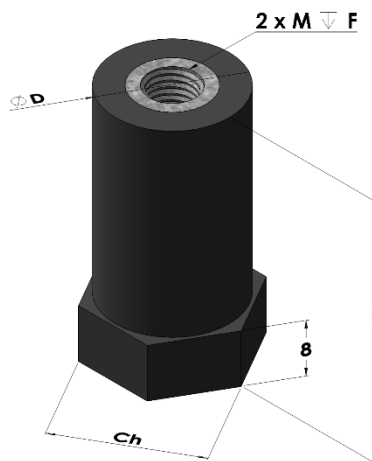

Please contact Teknomega for non-specified tolerances.