

## Product Datasheet

### ISO2155

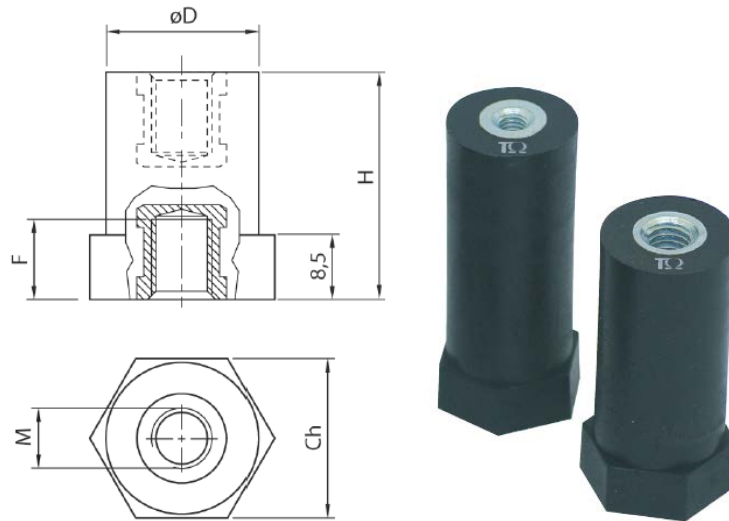

#### Main

Family	Low voltage insulators	
Version	Spacing columns in polyamide	
Code	ISO2155	
Reference	CLN 25M6-20	
Number per package	50	
Weight (Kg)	0.018	
Dimensions (mm)	H=25 Ch=21 D=20 F=5	
Type	Hexagonal	
Thread Size	M6	
Force Characteristics	Tightening torque*	8 Nm
	Tensile strength	5.5 kN
	Compressive strength	47 kN
	Flexural strength	3.5 kN

\*Maximum tightening torque value suggested for 8.8 class screws

## Technical Characteristics

### Insulation

Polyamide 6,6 reinforced with 35% fiberglass

Halogen Free

Self-extinguishing: UL 94-V0

Glow Wire Flammability Index: 960 °C

1,5% moisture absorption as per ISO 62

Color: black

### Threaded Inserts

Galvanized steel

### Finished product

**Rated voltage:** 1000 V AC/1500 V DC

**Working temperature:** -40 ÷ 125 °C

UL Recognized with file n° 300607

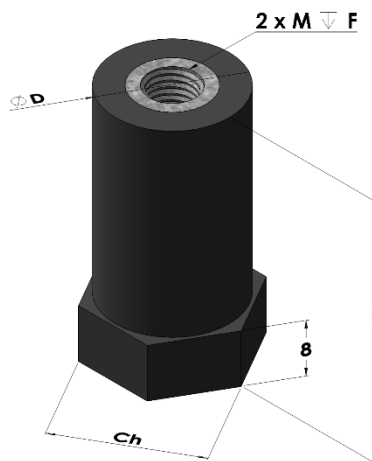

Please contact Teknomega for non-specified tolerances.