

Product Datasheet

ISO2030

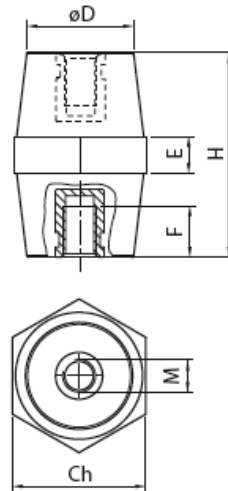

Main

Family	Low voltage insulators	
Version	Insulators in polyamide	
Code	ISO2030	
Reference	ISO 30M8 UL	
Number per package	50	
Weight (Kg)	0.035	
Dimensions (mm)	H=30 Ch=30 D=26 E=6 F=9	
Type	Hexagonal	
Thread Size	M8	
Force Characteristics	Tightening torque*	25 Nm
	Tensile strength	8 kN
	Compressive strength	75 kN
	Flexural strength	5 kN

*Maximum tightening torque value suggested for 8.8 class screws

Technical Characteristics

Insulation

Polyamide 6,6 reinforced with 35% fiberglass

Halogen Free

Self-extinguishing: UL 94-V0

Glow Wire Flammability Index: 960 °C

1,5% moisture absorption as per ISO 62

Color: black

Threaded Inserts

Galvanized steel

Finished product

Rated voltage: 1000 V AC/1500 V DC

Working temperature: -40 ÷ 125 °C

UL Recognized with file n° 300607

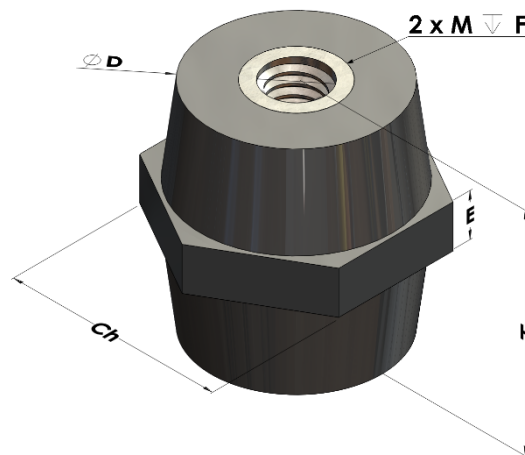

Please contact Teknomega for non-specified tolerances.