

Product Datasheet IPC1035

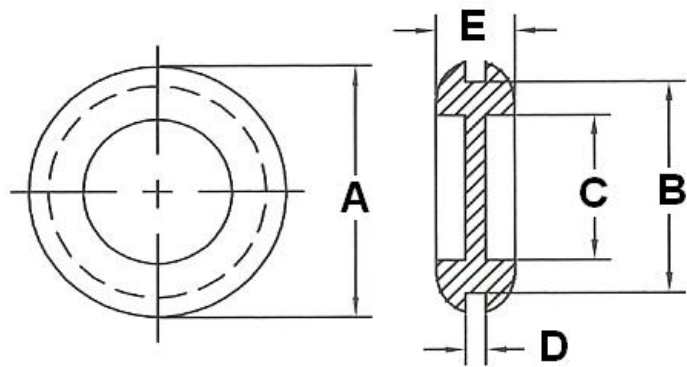

Main

Family	Wiring accessories
Version	Grommet inserts
Code	IPC1035
Reference	IPC DF47.5
Number per package	100
A (mm)	53
B (mm)	47.5
C (mm)	40
D (mm)	2.5
E (mm)	9.5

Technical Features

Material: PVC, black

Self-extinguishing: UL 94-HB

Working temperature: -20 °C ... +90 °C

Please contact Teknomega for non-specified tolerances.