

Product Datasheet

DZP1020

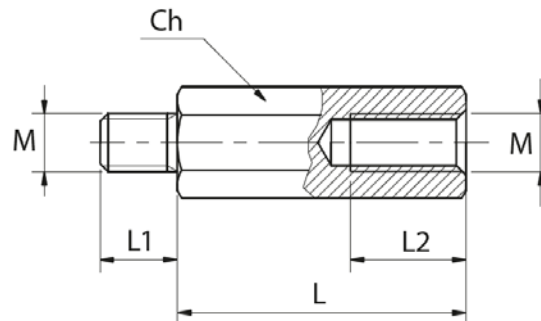

Main

Family	Wiring accessories
Version	Plastic spacers
Code	DZP1020
Reference	DZP 45M5
Number per package	50
Bolt size	M5
Ch (mm)	13
L (mm)	45
L1 (mm)	7
L2 (mm)	7

Technical Features

Material: polystyrene

Self-extinguishing: UL 94-HB

Working temperature: -40 °C ... +110 °C

Insulation voltage: 1000 V

M-F inserts: galvanized steel



Please contact Teknomega for non-specified tolerances.