

## Product Datasheet

### DZM1175

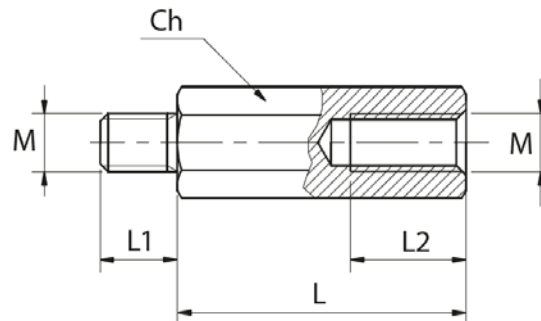

#### Main

Family	Wiring accessories
Version	Steel spacers
Code	DZM1175
Reference	DZM 70M8
Number per package	25
Ch (mm)	13
L (mm)	70
Screw size	M8
L1 (mm)	14
L2 (mm)	14

### Technical Features

**Material:** Steel with electrolytic cold galvanization

Hexagonal profile

M-F (Male-Female) thread

Tensile strength: 500 N/mm<sup>2</sup>

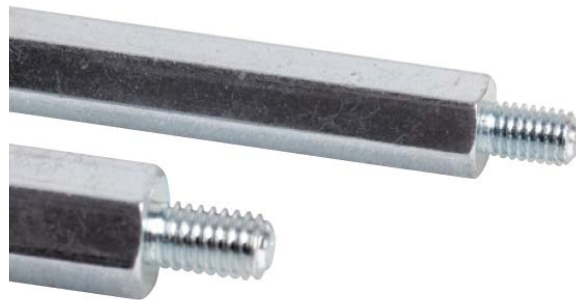

Please contact Teknomega for non-specified tolerances.