

Product Datasheet

DZM1170

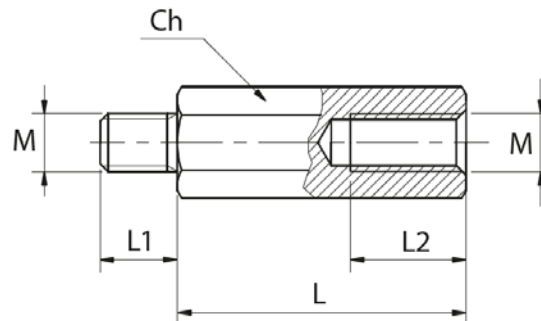

Main

Family	Wiring accessories
Version	Steel spacers
Code	DZM1170
Reference	DZM 50M8
Number per package	25
Ch (mm)	13
L (mm)	50
Screw size	M8
L1 (mm)	14
L2 (mm)	14

Technical Features

Material: Steel with electrolytic cold galvanization

Hexagonal profile

M-F (Male-Female) thread

Tensile strength: 500 N/mm²

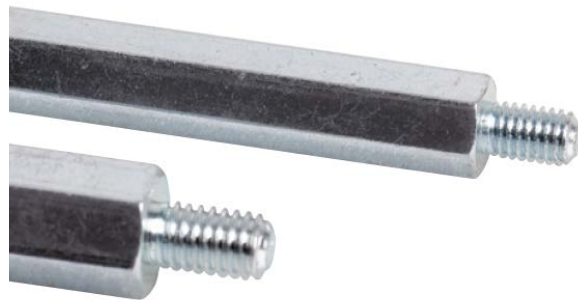

Please contact Teknomega for non-specified tolerances.