

Product Datasheet

DZM1130

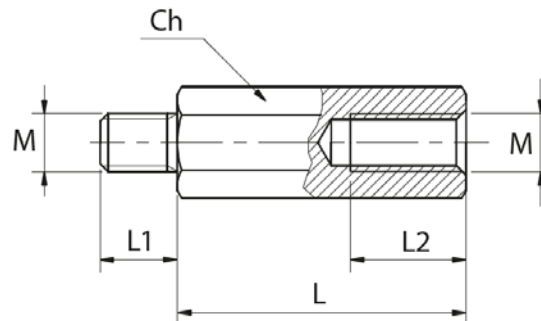

Main

Family	Wiring accessories
Version	Steel spacers
Code	DZM1130
Reference	DZM 70M6
Number per package	50
Ch (mm)	10
L (mm)	70
Screw size	M6
L1 (mm)	10
L2 (mm)	12

Technical Features

Material: Steel with electrolytic cold galvanization

Hexagonal profile

M-F (Male-Female) thread

Tensile strength: 500 N/mm²

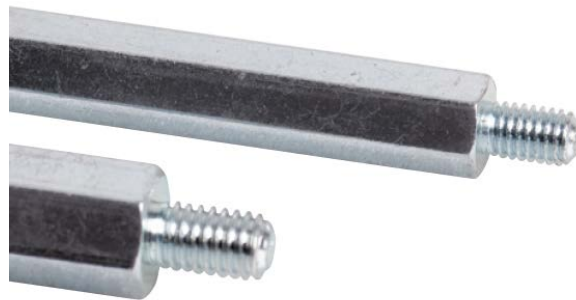

Please contact Teknomega for non-specified tolerances.