

## Product Datasheet

### DZM1095

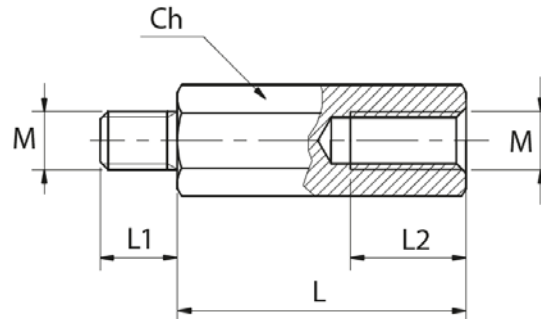

#### Main

Family	Wiring accessories
Version	Steel spacers
Code	DZM1095
Reference	DZM 10M6
Number per package	100
Ch (mm)	10
L (mm)	10
Screw size	M6
L1 (mm)	10
L2 (mm)	7

### Technical Features

**Material:** Steel with electrolytic cold galvanization

Hexagonal profile

M-F (Male-Female) thread

Tensile strength: 500 N/mm<sup>2</sup>

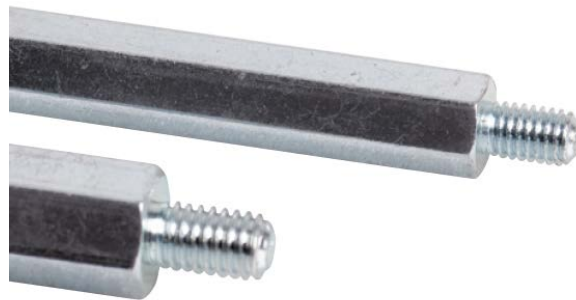

Please contact Teknomega for non-specified tolerances.