

Product Datasheet

DZM1080

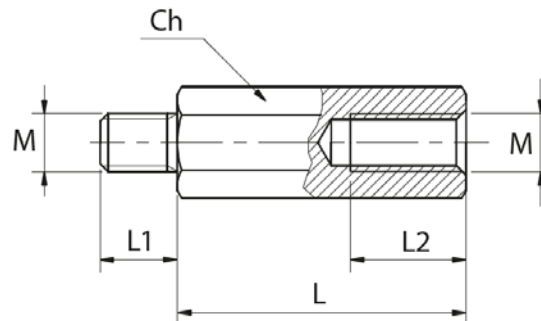

Main

Family	Wiring accessories
Version	Steel spacers
Code	DZM1080
Reference	DZM 60M5
Number per package	50
Ch (mm)	8
L (mm)	60
Screw size	M5
L1 (mm)	8
L2 (mm)	10

Technical Features

Material: Steel with electrolytic cold galvanization

Hexagonal profile

M-F (Male-Female) thread

Tensile strength: 500 N/mm²

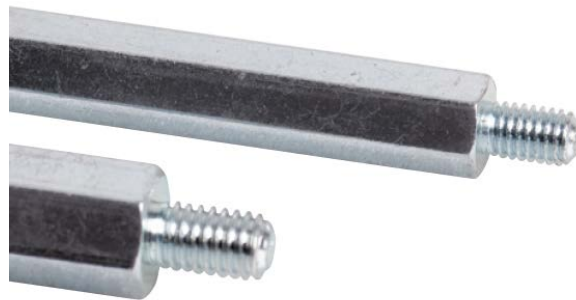

Please contact Teknomega for non-specified tolerances.