

## Product Datasheet

### DZM1045

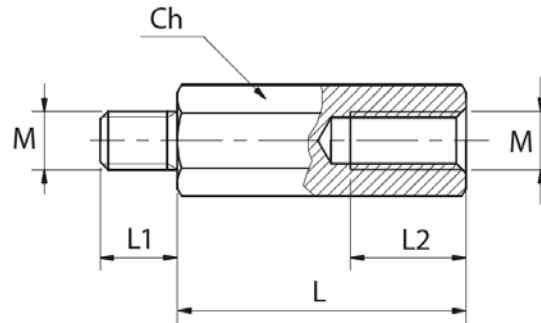

#### Main

Family	Wiring accessories
Version	Steel spacers
Code	DZM1045
Reference	DZM 15M5
Number per package	100
Ch (mm)	8
L (mm)	15
Screw size	M5
L1 (mm)	8
L2 (mm)	10

### Technical Features

**Material:** Steel with electrolytic cold galvanization

Hexagonal profile

M-F (Male-Female) thread

Tensile strength: 500 N/mm<sup>2</sup>



Please contact Teknomega for non-specified tolerances.