

Product Datasheet

DZM1025

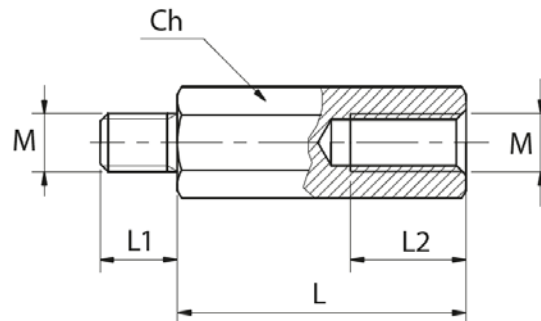

Main

Family	Wiring accessories
Version	Steel spacers
Code	DZM1025
Reference	DZM 35M4
Number per package	100
Ch (mm)	7
L (mm)	35
Screw size	M4
L1 (mm)	8
L2 (mm)	10

Technical Features

Material: Steel with electrolytic cold galvanization

Hexagonal profile

M-F (Male-Female) thread

Tensile strength: 500 N/mm²

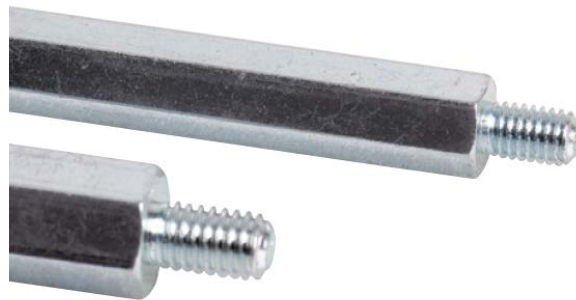

Please contact Teknomega for non-specified tolerances.