

Product Datasheet

DZM0995

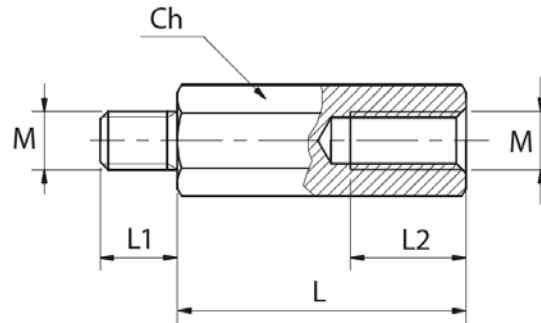

Main

Family	Wiring accessories
Version	Steel spacers
Code	DZM0995
Reference	DZM 20M3
Number per package	100
Ch (mm)	6
L (mm)	20
Screw size	M3
L1 (mm)	6
L2 (mm)	10

Technical Features

Material: Steel with electrolytic cold galvanization

Hexagonal profile

M-F (Male-Female) thread

Tensile strength: 500 N/mm²



Please contact Teknomega for non-specified tolerances.