

## Product Datasheet

### DIN1150

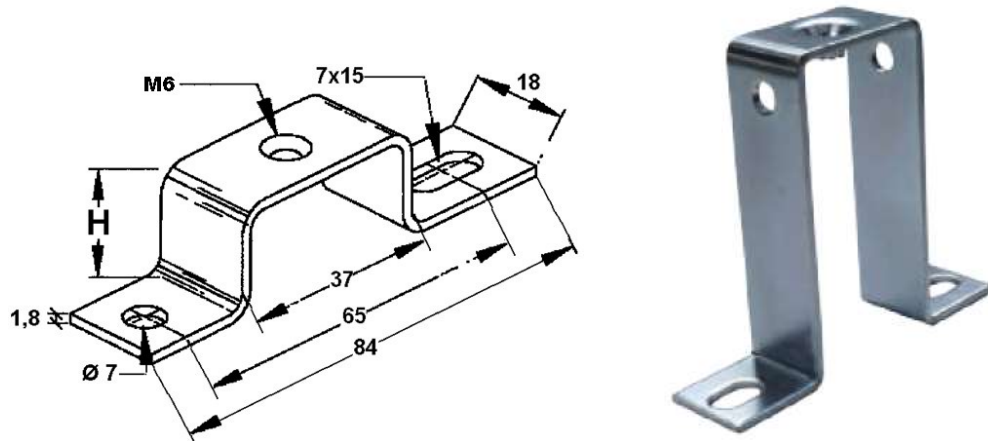

#### Main

Family	Accessories for DIN rails
Version	Flat supports
Code	DIN1150
Reference	DIN STC 90-6
Number per package	10
H (mm)	90

#### Technical Features

**Material:** Passivated galvanized steel

Please contact Teknomega for non-specified tolerances.