

Product Datasheet

DIN1135

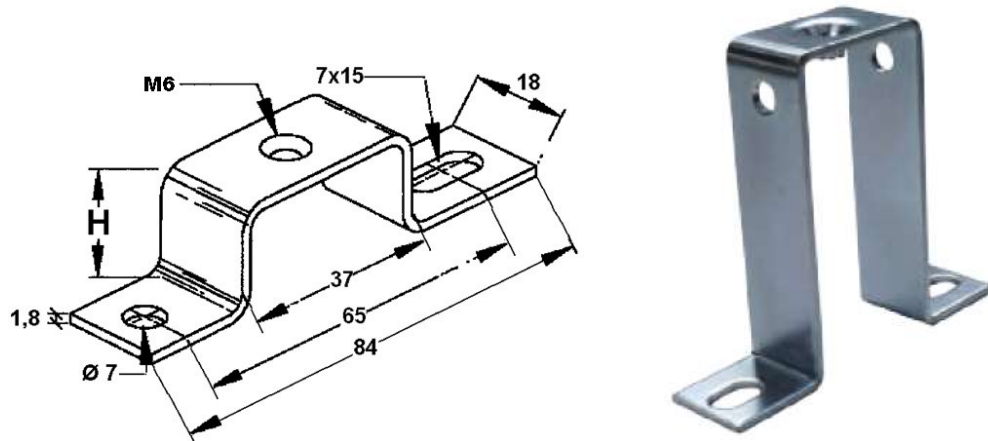

Main

Family	Accessories for DIN rails
Version	Flat supports
Code	DIN1135
Reference	DIN STC 40-6
Number per package	10
H (mm)	40

Technical Features

Material: Passivated galvanized steel

Please contact Teknomega for non-specified tolerances.