

## Product Datasheet

### DIN1115

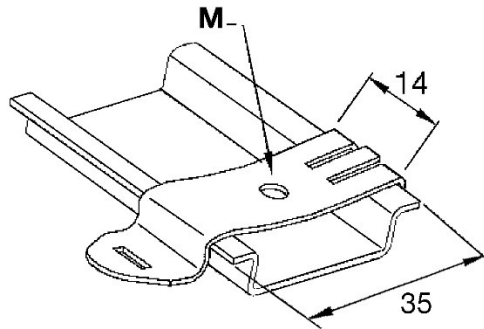

#### Main

Family	Accessories for DIN rails
Version	Clip for symmetrical ( $\Omega$ ) DIN rails
Code	DIN1115
Reference	DIN KLIP 5
Number per package	100
M	M5

#### Technical Features

**Material:** nickel-plated steel

Clip compatible with rails SYMMETRICAL DIN " $\Omega$ " 35x7.5 and 35x15

Please contact Teknomega for non-specified tolerances.