

Product Datasheet

DIN1045

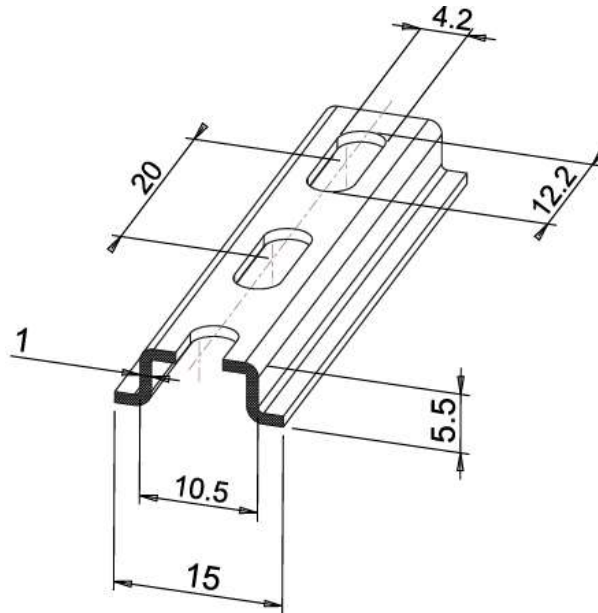

Main

Family	DIN rails and profiles
Version	Passivated galvanized steel
Code	DIN1045
Reference	DIN F15H5
Type	Symmetrical (Ω) punched DIN rail, 15 x 5.5 mm
Length (m)	2
Number per package	20
Weight (kg)	0.33
Holes	Yes

Technical Features

Material: Passivated galvanized DC01 steel, minimum thickness 6 μm

Compliance to EN 60715 – DIN 46277

Standard length: 2 meters



Please contact Teknomega for non-specified tolerances.