

## Product Datasheet

### CPH2650

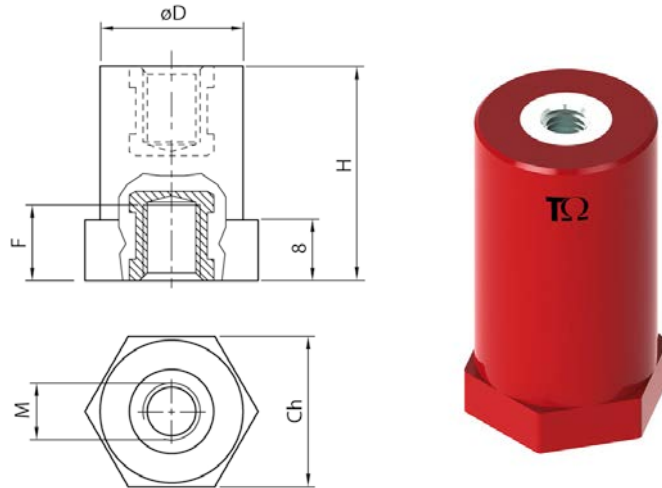

#### Main

Family	Low voltage insulators	
Version	Spacing columns in polyester	
Code	CPH2650	
Reference	CLH 65M6-30	
Number per package	10	
Weight (Kg)	0.131	
Dimensions (mm)	H=65 Ch=30 D=30 F=16	
Type	Hexagonal	
Thread Size	M6	
Force Characteristics	Tightening torque*	10 Nm
	Tensile strength	8 kN
	Compressive strength	47 kN
	Flexural strength	1.7 kN

\*Maximum tightening torque value suggested for 8.8 class screws

## Technical Features

### Insulation

Thermosetting Polyester reinforced with fiberglass

Self-extinguishing: UL 94-V0

Color: Red RAL 3031

### Threaded Inserts

Galvanized steel

### Finished product

**Rated voltage:** 1000 V AC/1500 V DC

**Working temperature:** -40 to 130 °C

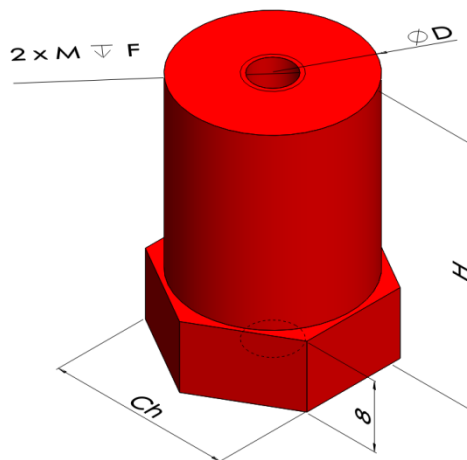

Please contact Teknomega for non-specified tolerances.