

Product Datasheet

CPH2640

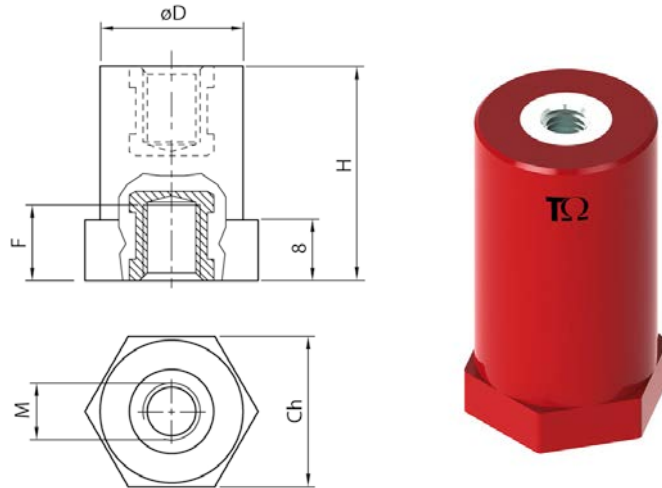

Main

Family	Low voltage insulators	
Version	Spacing columns in polyester	
Code	CPH2640	
Reference	CLH 55M6-30	
Number per package	10	
Weight (Kg)	0.117	
Dimensions (mm)	H=55 Ch=30 D=30 F=16	
Type	Hexagonal	
Thread Size	M6	
Force Characteristics	Tightening torque*	10 Nm
	Tensile strength	8 kN
	Compressive strength	50 kN
	Flexural strength	1.8 kN

*Maximum tightening torque value suggested for 8.8 class screws

Technical Features

Insulation

Thermosetting Polyester reinforced with fiberglass

Self-extinguishing: UL 94-V0

Color: Red RAL 3031

Threaded Inserts

Galvanized steel

Finished product

Rated voltage: 1000 V AC/1500 V DC

Working temperature: -40 to 130 °C

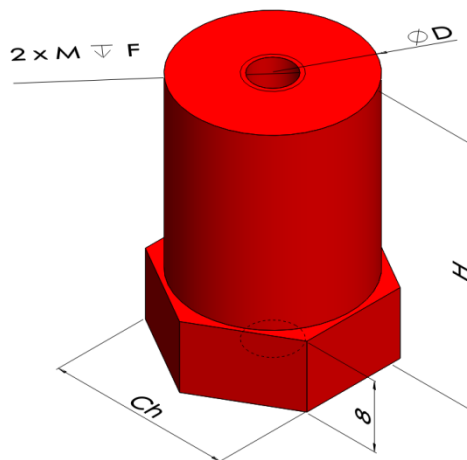

Please contact Teknomega for non-specified tolerances.