

## Product Datasheet

### CPH2590

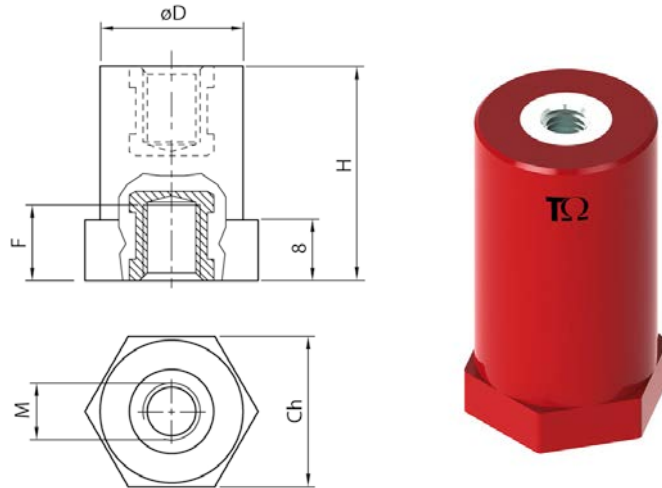

#### Main

Family	Low voltage insulators	
Version	Spacing columns in polyester	
Code	CPH2590	
Reference	CLH 50M8-20	
Number per package	10	
Weight (Kg)	0.039	
Dimensions (mm)	H=50 Ch=21 D=20 F=10	
Type	Hexagonal	
Thread Size	M8	
Force Characteristics	Tightening torque*	25 Nm
	Tensile strength	3.7 kN
	Compressive strength	23 kN
	Flexural strength	1 kN

\*Maximum tightening torque value suggested for 8.8 class screws

## Technical Features

### Insulation

Thermosetting Polyester reinforced with fiberglass

Self-extinguishing: UL 94-V0

Color: Red RAL 3031

### Threaded Inserts

Galvanized steel

### Finished product

**Rated voltage:** 1000 V AC/1500 V DC

**Working temperature:** -40 to 130 °C

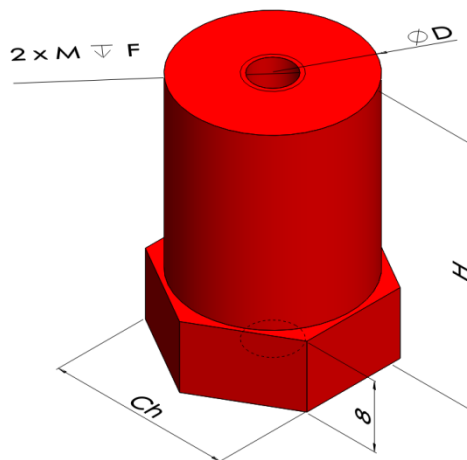

Please contact Teknomega for non-specified tolerances.