

Product Datasheet

CPH2565

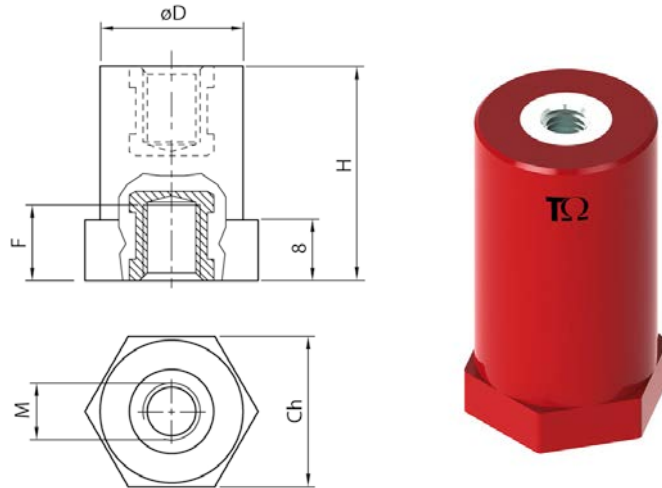

Main

Family	Low voltage insulators	
Version	Spacing columns in polyester	
Code	CPH2565	
Reference	CLH 40M6-20	
Number per package	10	
Weight (Kg)	0.034	
Dimensions (mm)	H=40 Ch=21 D=20 F=10	
Type	Hexagonal	
Thread Size	M6	
Force Characteristics	Tightening torque*	10 Nm
	Tensile strength	3.7 kN
	Compressive strength	23 kN
	Flexural strength	1.3 kN

*Maximum tightening torque value suggested for 8.8 class screws

Technical Features

Insulation

Thermosetting Polyester reinforced with fiberglass

Self-extinguishing: UL 94-V0

Color: Red RAL 3031

Threaded Inserts

Galvanized steel

Finished product

Rated voltage: 1000 V AC/1500 V DC

Working temperature: -40 to 130 °C

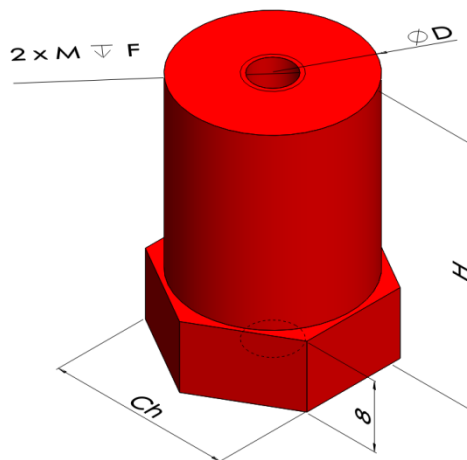

Please contact Teknomega for non-specified tolerances.