

Product Datasheet

CPH2100

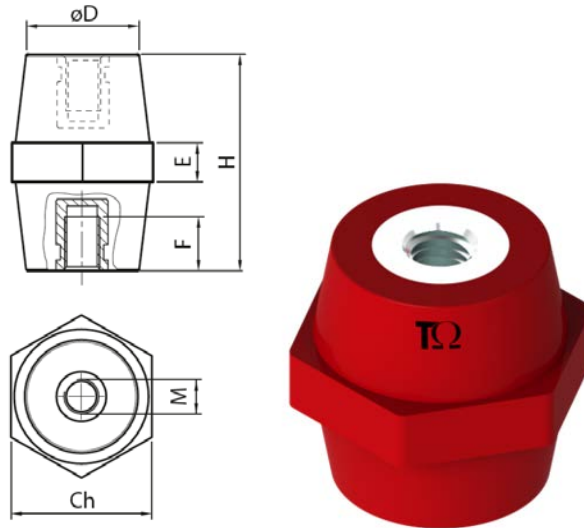

Main

Family	Low voltage insulators	
Version	Insulators in polyester	
Code	CPH2100	
Reference	CPH 60M10	
Number per package	4	
Weight (kg)	0.330	
Dimensions (mm)	H=60 Ch=60 D=49 E=15 F=20	
Type	Hexagonal	
Thread Size	M10	
Force Characteristics	Tightening torque*	50 Nm
	Tensile strength	14 kN
	Compressive strength	180 kN
	Flexural strength	7.5 kN

*Maximum tightening torque value suggested for 8.8 class screws

Technical Characteristics

Insulation

Thermosetting polyester reinforced with fiberglass

Self-extinguishing: UL94-V0

Color: red RAL 3031

Threaded Inserts

Galvanized steel

Finished product

Rated voltage: 1000 V AC/1500 V DC

Working temperature: -40 ÷ 130 °C

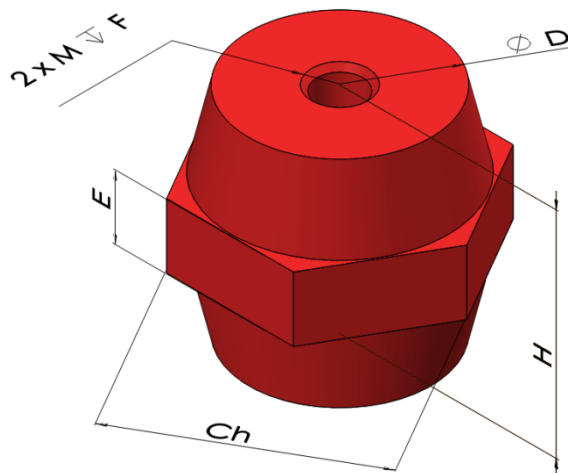

Please contact Teknomega for non-specified tolerances