

## Product Datasheet

### CPH2090

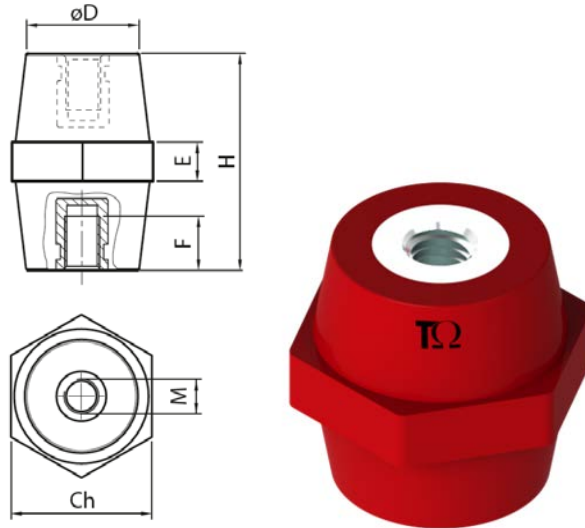

#### Main

Family	Low voltage insulators	
Version	Insulators in polyester	
Code	CPH2090	
Reference	CPH 50M10	
Number per package	10	
Weight (kg)	0.168	
Dimensions (mm)	H=50 Ch=46 D=37 E=10 F=15	
Type	Hexagonal	
Thread Size	M10	
Force Characteristics	Tightening torque*	50 Nm
	Tensile strength	11 kN
	Compressive strength	120 kN
	Flexural strength	5.5 kN

\*Maximum tightening torque value suggested for 8.8 class screws

## Technical Characteristics

### Insulation

Thermosetting polyester reinforced with fiberglass

Self-extinguishing: UL94-V0

Color: red RAL 3031

### Threaded Inserts

Galvanized steel

### Finished product

**Rated voltage:** 1000 V AC/1500 V DC

**Working temperature:** -40 ÷ 130 °C

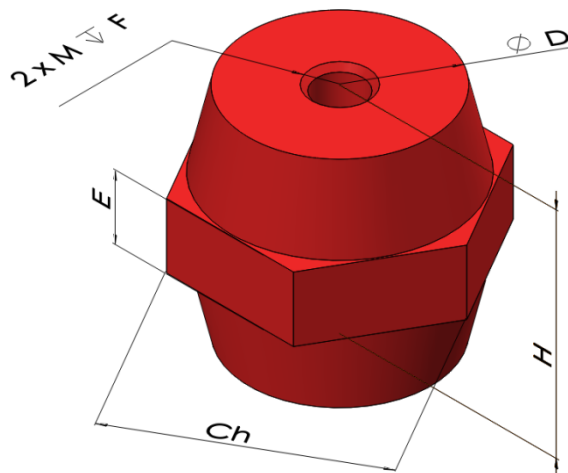

Please contact Teknomega for non-specified tolerances