

Product Datasheet

CPH2065

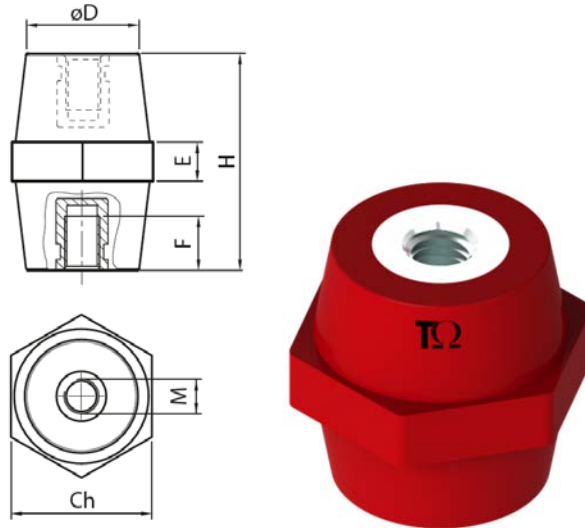

Main

Family	Low voltage insulators	
Version	Insulators in polyester	
Code	CPH2065	
Reference	CPH 45M6	
Number per package	10	
Weight (kg)	0.173	
Dimensions (mm)	H=45 Ch=46 D=39 E=13 F=12	
Type	Hexagonal	
Thread Size	M6	
Force Characteristics	Tightening torque*	10 Nm
	Tensile strength	9 kN
	Compressive strength	140 kN
	Flexural strength	5.4 kN

*Maximum tightening torque value suggested for 8.8 class screws

Technical Characteristics

Insulation

Thermosetting polyester reinforced with fiberglass

Self-extinguishing: UL94-V0

Color: red RAL 3031

Threaded Inserts

Galvanized steel

Finished product

Rated voltage: 1000 V AC/1500 V DC

Working temperature: -40 ÷ 130 °C

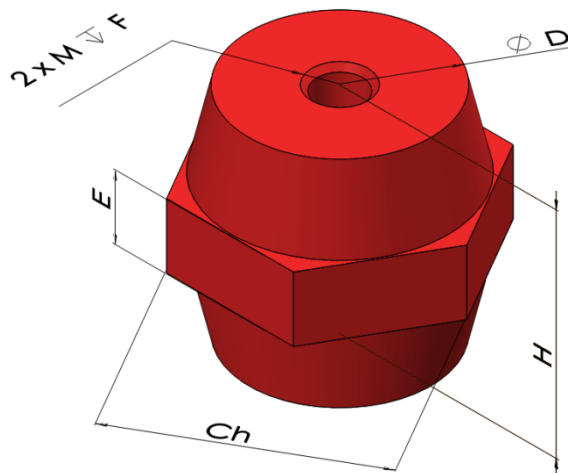

Please contact Teknomega for non-specified tolerances