

Product Datasheet

CPH2030

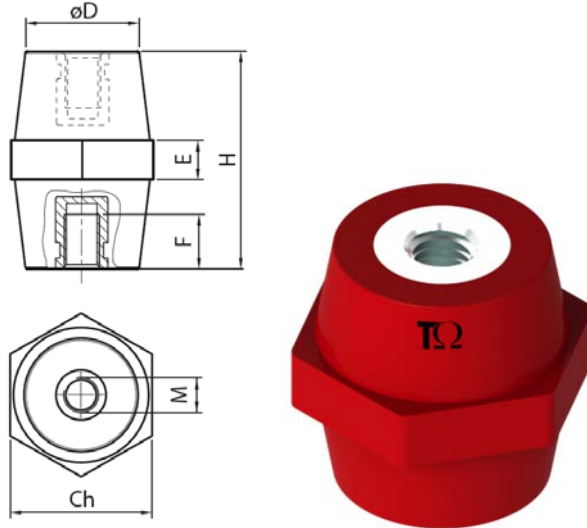

Main

Family	Low voltage insulators	
Version	Insulators in polyester	
Code	CPH2030	
Reference	CPH 30M8	
Number per package	10	
Weight (kg)	0.062	
Dimensions (mm)	H=30 Ch=30 D=25 E=7 F=10	
Type	Hexagonal	
Thread Size	M8	
Force Characteristics	Tightening torque*	25 Nm
	Tensile strength	5.8 kN
	Compressive strength	59 kN
	Flexural strength	3.9 kN

*Maximum tightening torque value suggested for 8.8 class screws

Technical Characteristics

Insulation

Thermosetting polyester reinforced with fiberglass

Self-extinguishing: UL94-V0

Color: red RAL 3031

Threaded Inserts

Galvanized steel

Finished product

Rated voltage: 1000 V AC/1500 V DC

Working temperature: -40 ÷ 130 °C

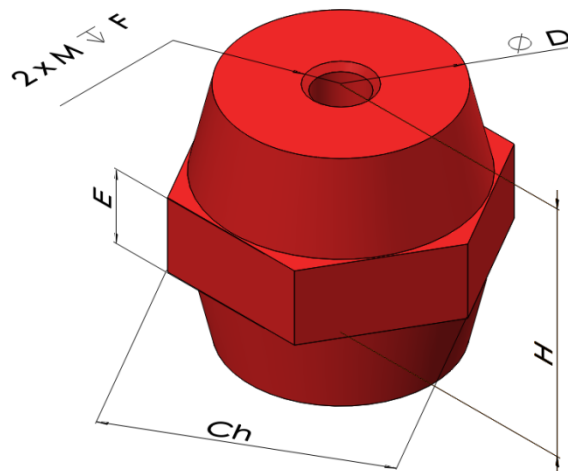

Please contact Teknomega for non-specified tolerances