

Product Datasheet

CPH2020

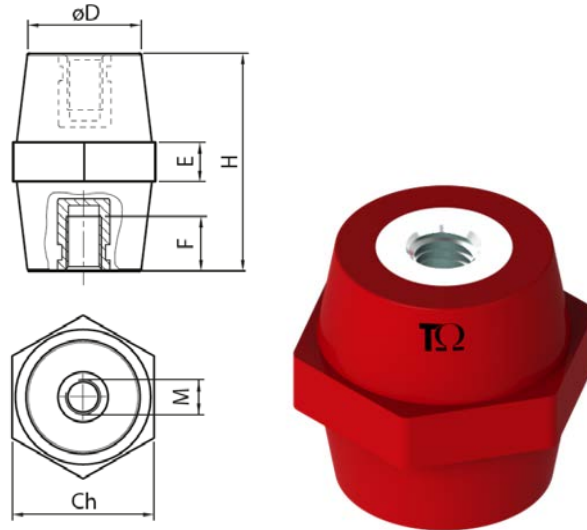

Main

Family	Low voltage insulators	
Version	Insulators in polyester	
Code	CPH2020	
Reference	CPH 25M6	
Number per package	20	
Weight (kg)	0.022	
Dimensions (mm)	H=25 Ch=22 D=18 E=6 F=7	
Type	Hexagonal	
Thread Size	M6	
Force Characteristics	Tightening torque*	10 Nm
	Tensile strength	3.4 kN
	Compressive strength	29 kN
	Flexural strength	2.2 kN

*Maximum tightening torque value suggested for 8.8 class screws

Technical Characteristics

Insulation

Thermosetting polyester reinforced with fiberglass

Self-extinguishing: UL94-V0

Color: red RAL 3031

Threaded Inserts

Galvanized steel

Finished product

Rated voltage: 1000 V AC/1500 V DC

Working temperature: -40 ÷ 130 °C

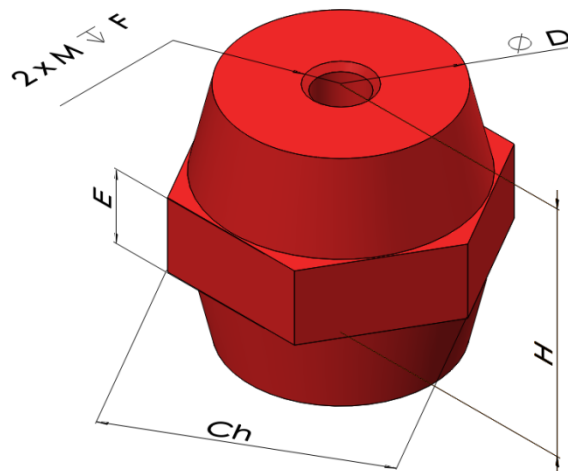

Please contact Teknomega for non-specified tolerances