

Product Datasheet

CPH2007

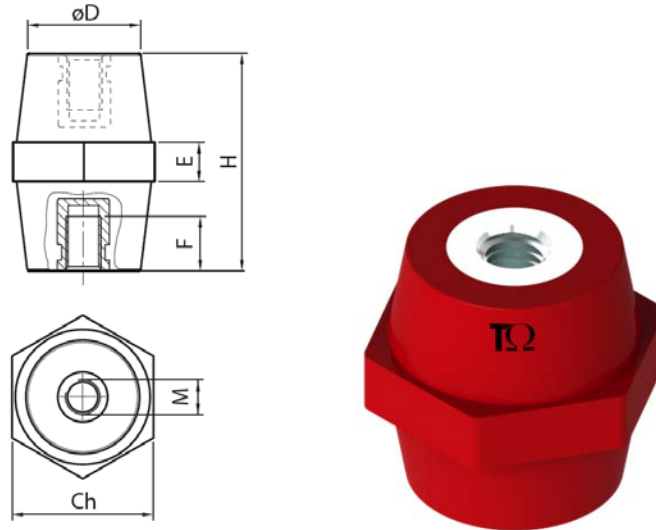

Main

Family	Low voltage insulators	
Version	Insulators in polyester	
Code	CPH2007	
Reference	CPH 20M5	
Number per package	25	
Weight (kg)	0.014	
Dimensions (mm)	H=20 Ch=19 D=16 E=5 F=6	
Type	Hexagonal	
Thread Size	M5	
Force Characteristics	Tightening torque*	6 Nm
	Tensile strength	2 kN
	Compressive strength	20 kN
	Flexural strength	1.5 kN

*Maximum tightening torque value suggested for 8.8 class screws

Technical Characteristics

Insulation

Thermosetting polyester reinforced with fiberglass

Self-extinguishing: UL94-V0

Color: red RAL 3031

Threaded Inserts

Galvanized steel

Finished product

Rated voltage: 1000 V AC/1500 V DC

Working temperature: -40 ÷ 130 °C

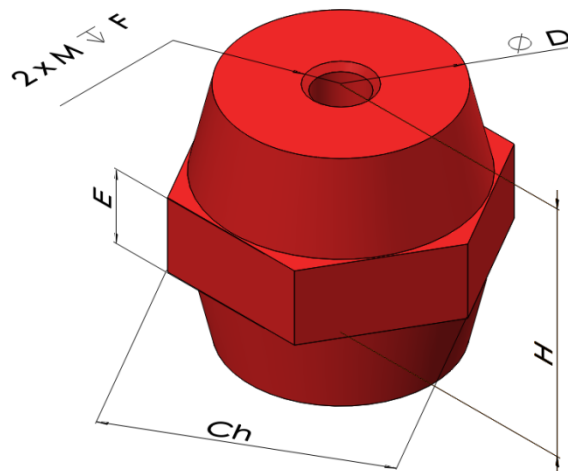

Please contact Teknomega for non-specified tolerances